

***advanced FLOW engineering***

Cold Air Intake System

**Instruction Manual** P/N: 56-70070D / 56-70070R

Make: MAZDA  
Make: MAZDA  
Make: MAZDA

Model: CX-60  
Model: CX-70  
Model: CX-90

Year: 2025-2027  
Year: 2025-2027  
Year: 2024-2027

Engine: L6-3.3L (t)  
Engine: L6-3.3L (t)  
Engine: L6-3.3L (t)



- Please read the entire instruction manual before proceeding.
- Ensure all components listed are present.
- If you are missing any of the components, call customer support at 951-493-7185.
- Ensure you have all necessary tools before proceeding.
- Do not attempt to work on your vehicle when the engine is hot.
- Retain factory parts for future use.

| Label | Qty. | Description                                     | Part Number  |
|-------|------|---|--------------|
| A     | 1    | Air Filter (Pro DRY S) For 56-70071D            | 21-91113     |
| A     | 1    | Air Filter (Pro 5R) For 56-70071R               | 24-91113     |
| B     | 1    | Tube  | 05-5670070B1 |
| C     | 1    | Housing   | 05-5670070B2 |
| D     | 1    | Clamp, 048 (2-9/16" – 3-1/2")                   | 03-50007     |
| E     | 1    | Clamp, 044 (2-5/16" – 3-1/4")                   | 03-50019     |
| F     | 2    | Grommet   | 03-50076     |
| G     | 1    | Clamp, Mini 16 (15/16" – 1-1/2")                | 03-50091     |
| H     | 2    | Screw, Torx: M4 x 8mm                           | 03-50491     |
| J     | 1    | Cap, Vinyl (1.3/8" – 1-7/16")                   | 03-50747     |
| K     | 2    | Spacer, Aluminum                                | 03-50772     |
| M     | 1    | Plug, Housing                                   | 05-01527     |
| N     | 1    | Coupler, Silicone Reducer: (2.75" x 3")ID x 3"L | 05-01528     |

**Installation will require the following tools:**

Socket Set, Torx Set, Extensions, Ratchet wrench, Pliers, Screwdriver Set, Trim Removal Tool

Warranty Information available at: <https://afepower.com/warranty>

**Emissions Disclaimer:** This product is not currently CARB exempt and is not available for purchase in California or for use on any vehicle registered with the California Department of Motor Vehicles. CARB exemption applications can take time to process, please contact us or visit our website for the latest updates on its status.

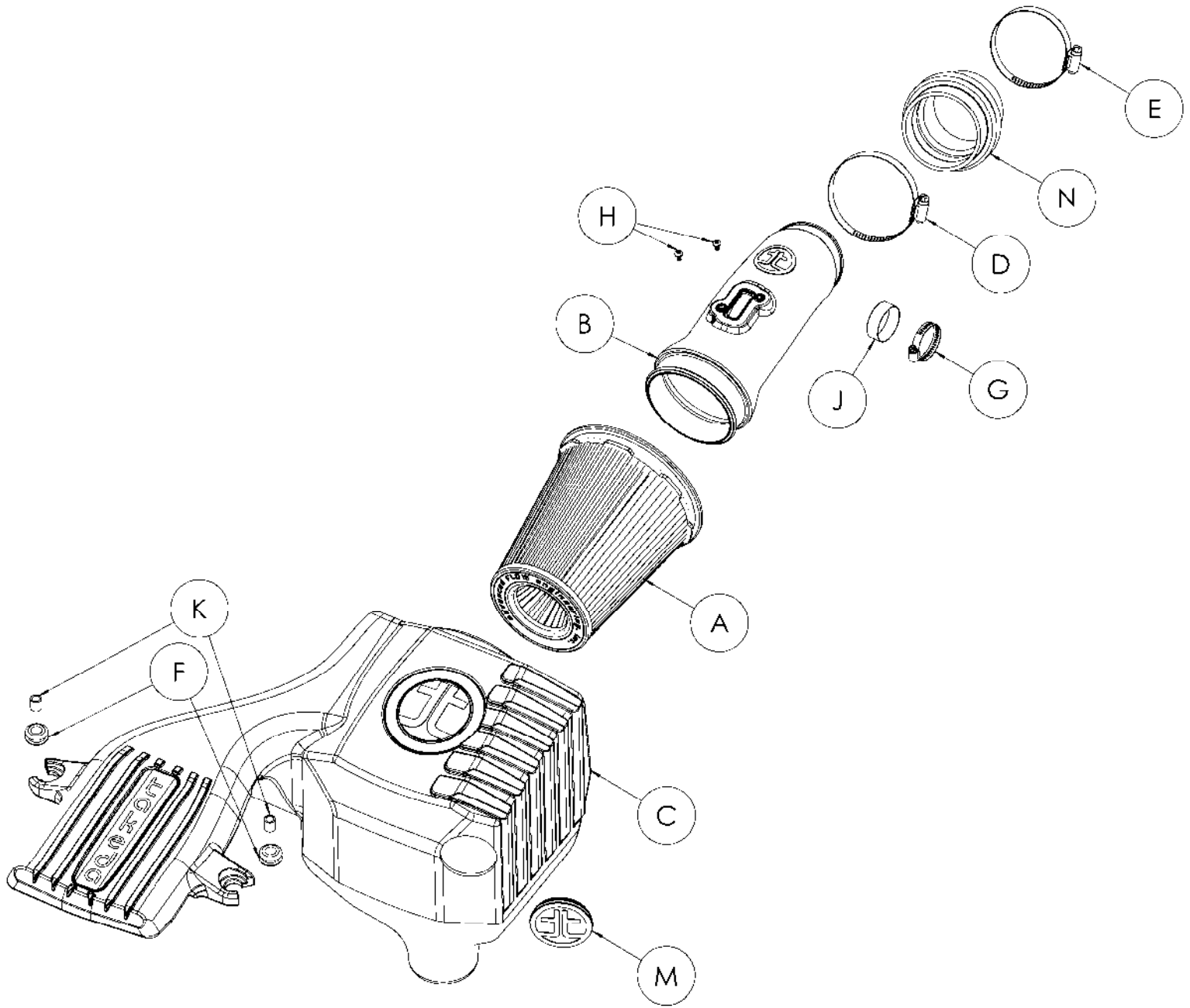

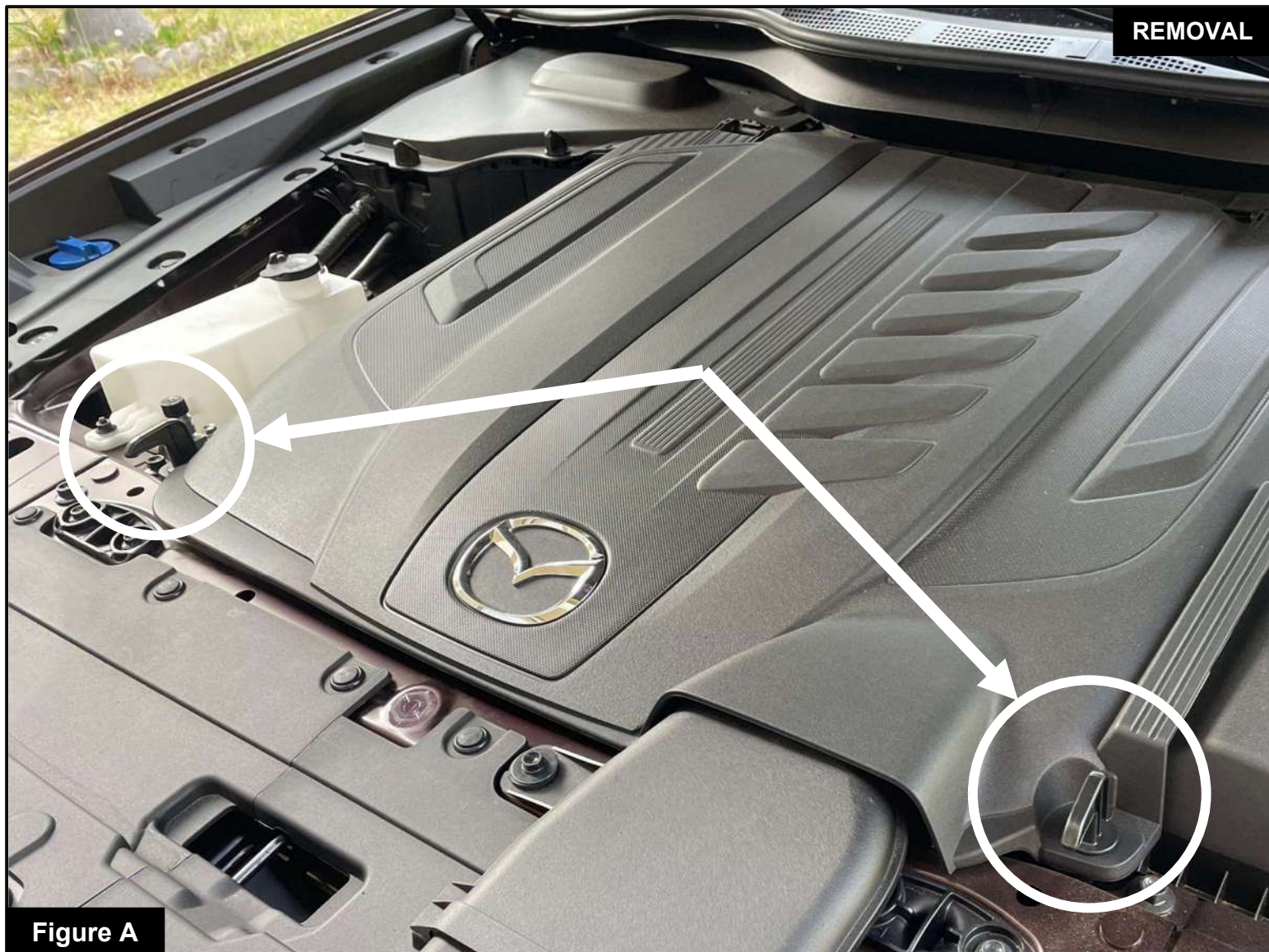

Figure A

**Refer to Figure A for Step 1**

Step 1: Turn the locking tabs on the engine cover by hand to the unlock position.

**Figure B****Refer to Figure B for Step 2**

Step 2: Lift the engine cover and use the anchor shown to secure it to the hood.

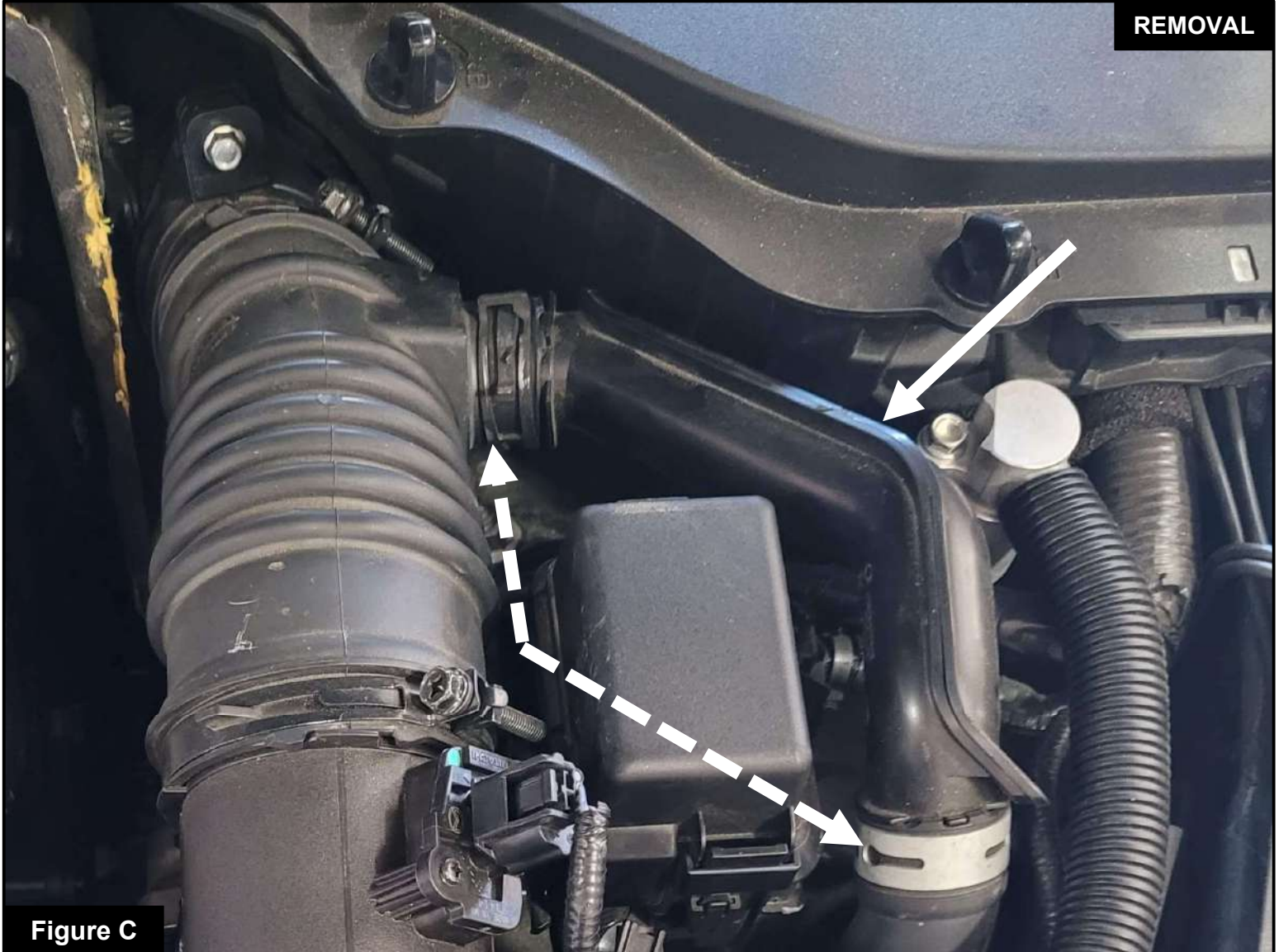
**Figure C****Refer to Figure C for Step 3**

Step 3: Use pliers to compress both factory pinch clamps in order to remove the factory intermediate sound tube. On some models, a permanent hose clamp may be installed. In these cases, it is typically easiest to remove the clamp only from the intake tube side.

**Note: Certain trims may not have this sound tube. If absent, proceed to the next step.**



Figure D

**Refer to Figure D for Steps 4-5**

Step 4: Use pliers to compress the bottom of the harness holder to unclip from mounting point.

Step 5: Press the release tab on the Mass Air Flow (MAF) sensor harness and disconnect it from the Mass Air Flow (MAF) sensor.

**Figure E****Refer to Figure E for Step 6**

Step 6: Use a 10mm driver or ratchet wrench to remove the (2) two screws that secure the factory housing. Screws will be used later in the installation.

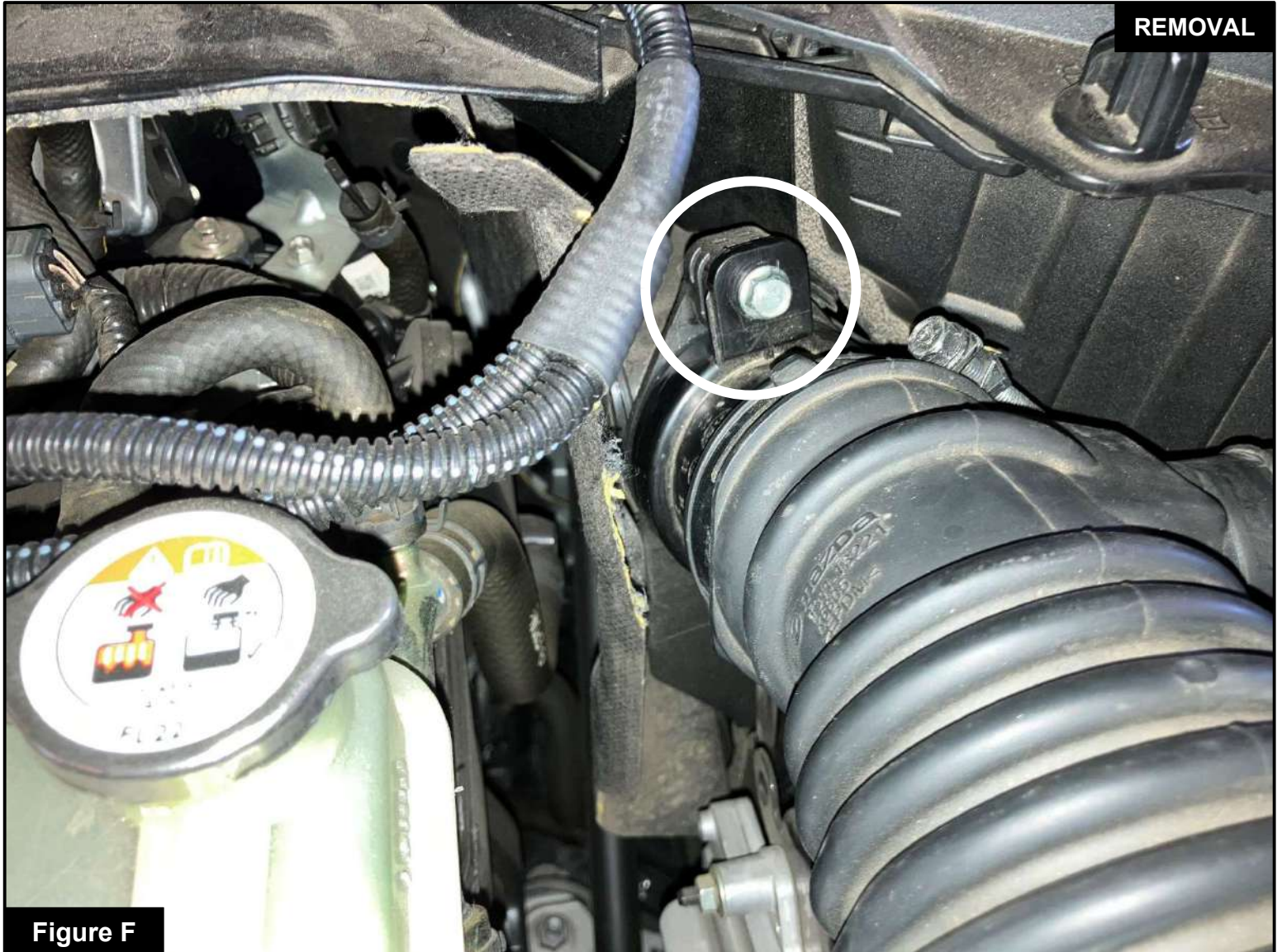

Figure F

**Refer to Figure F for Step 7**

Step 7: Use a 10mm driver or ratchet wrench to remove the screw securing the factory intake tube coupler.



**Refer to Figure G for Step 8**

Step 8: Take note to ensure all components are fully disconnected before carefully removing the factory intake as a single unit.

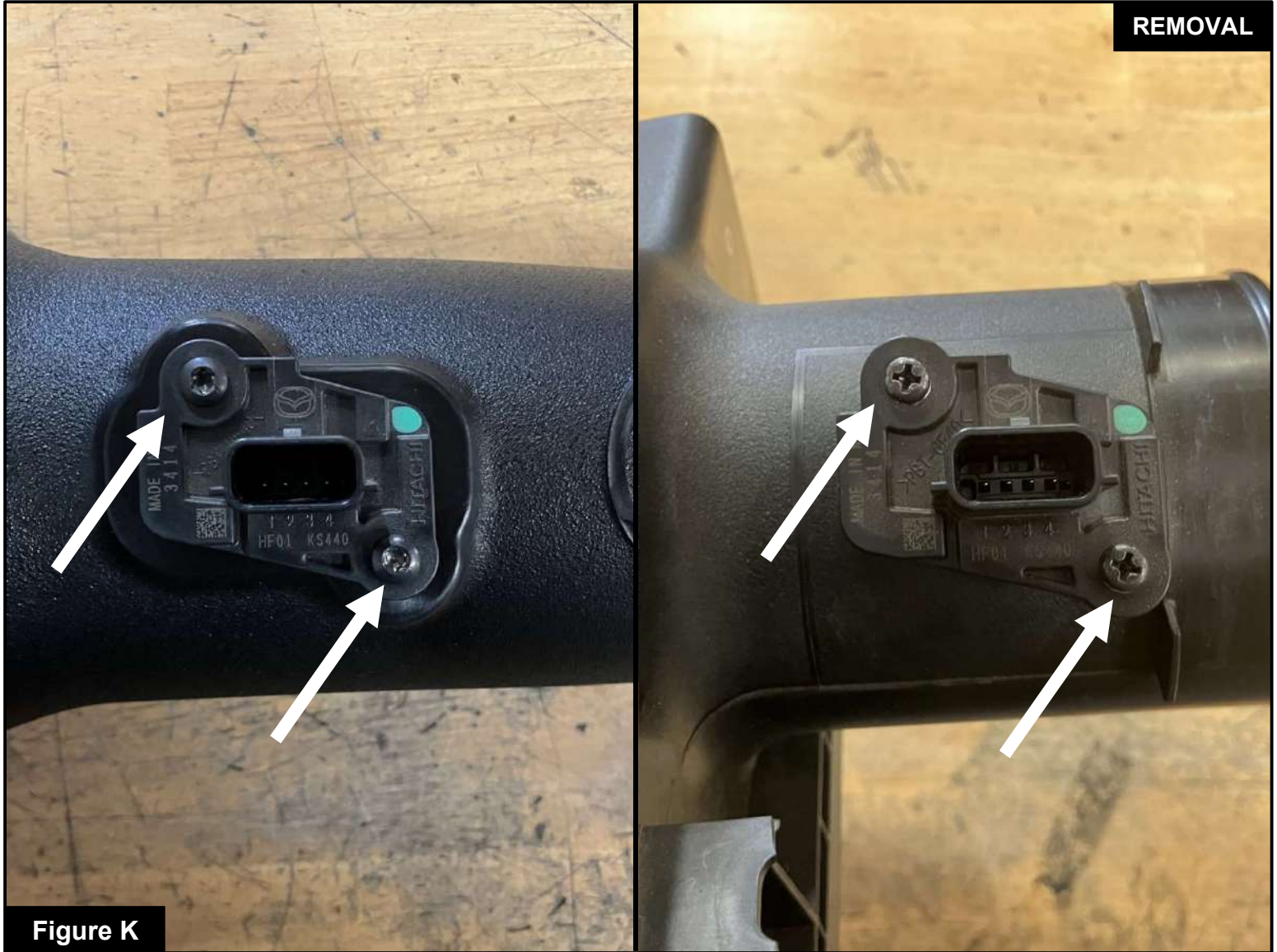

Figure K

**Refer to Figure K for Steps 9-10**

Step 9: Use a Phillips screwdriver to remove the screws securing the Mass Air Flow (MAF) sensor to the factory housing.

Step 10: Transfer the Mass Air Flow (MAF) sensor to the **TAKEDA** tube and secure it using the two (2) supplied Torx M4 screws.

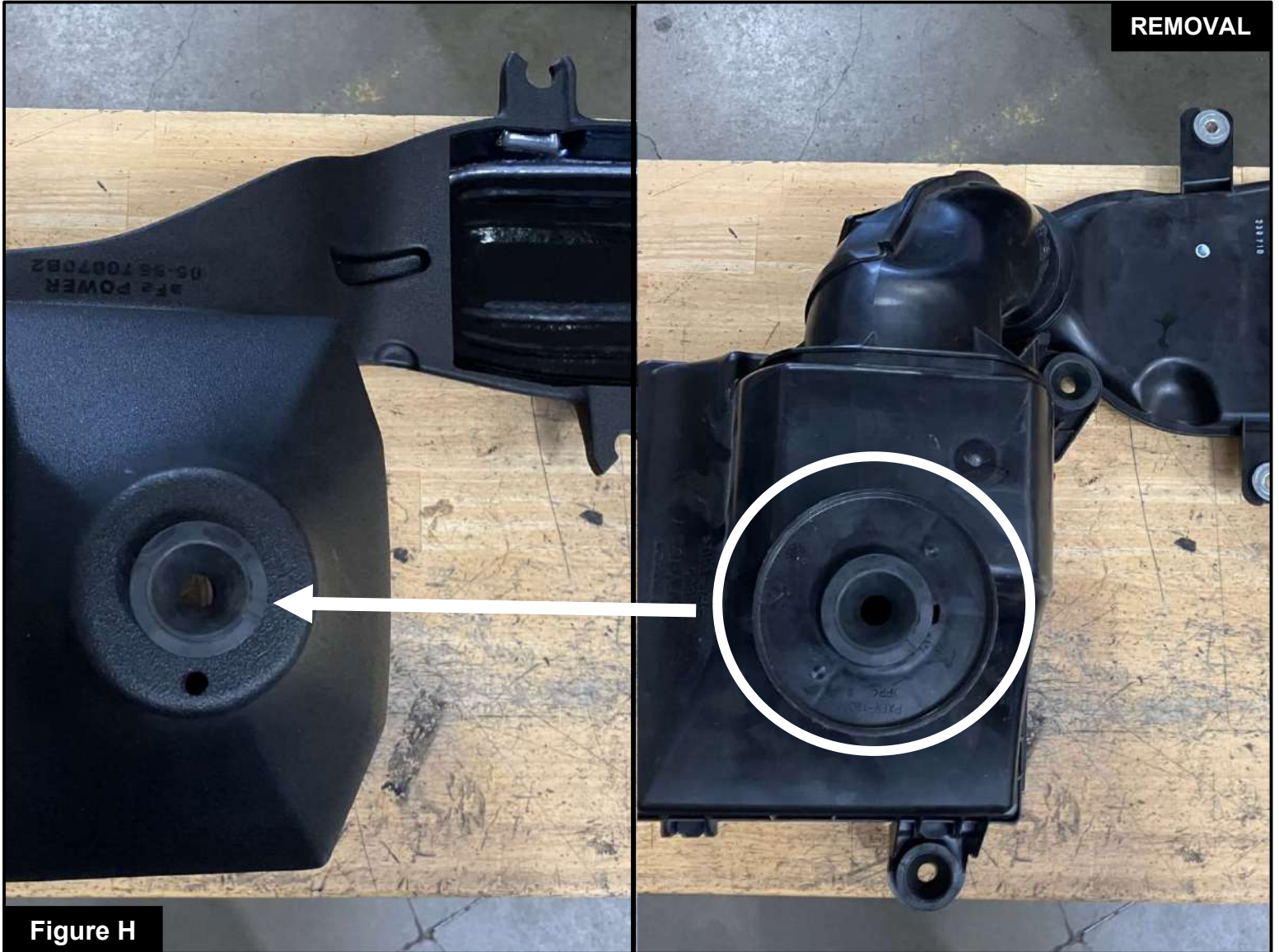

Figure H

**Refer to Figure H for Step 11**

Step 11: Transfer the bottom mounting grocket from the factory housing to the **TAKEDA** housing.

**Figure J****Refer to Figure J for Step 12**

Step 12: Install the provided rubber grommets onto the **TAKEDA** housing, then insert the provided aluminum spacers inside the rubber grommets.



Figure K

**Refer to Figure K for Step 13**

Step 13: Install the **aFe POWER** air filter into the **TAKEDA** housing by firmly pushing until the filter tabs lock it into place. Do not tighten hose clamp at this time.

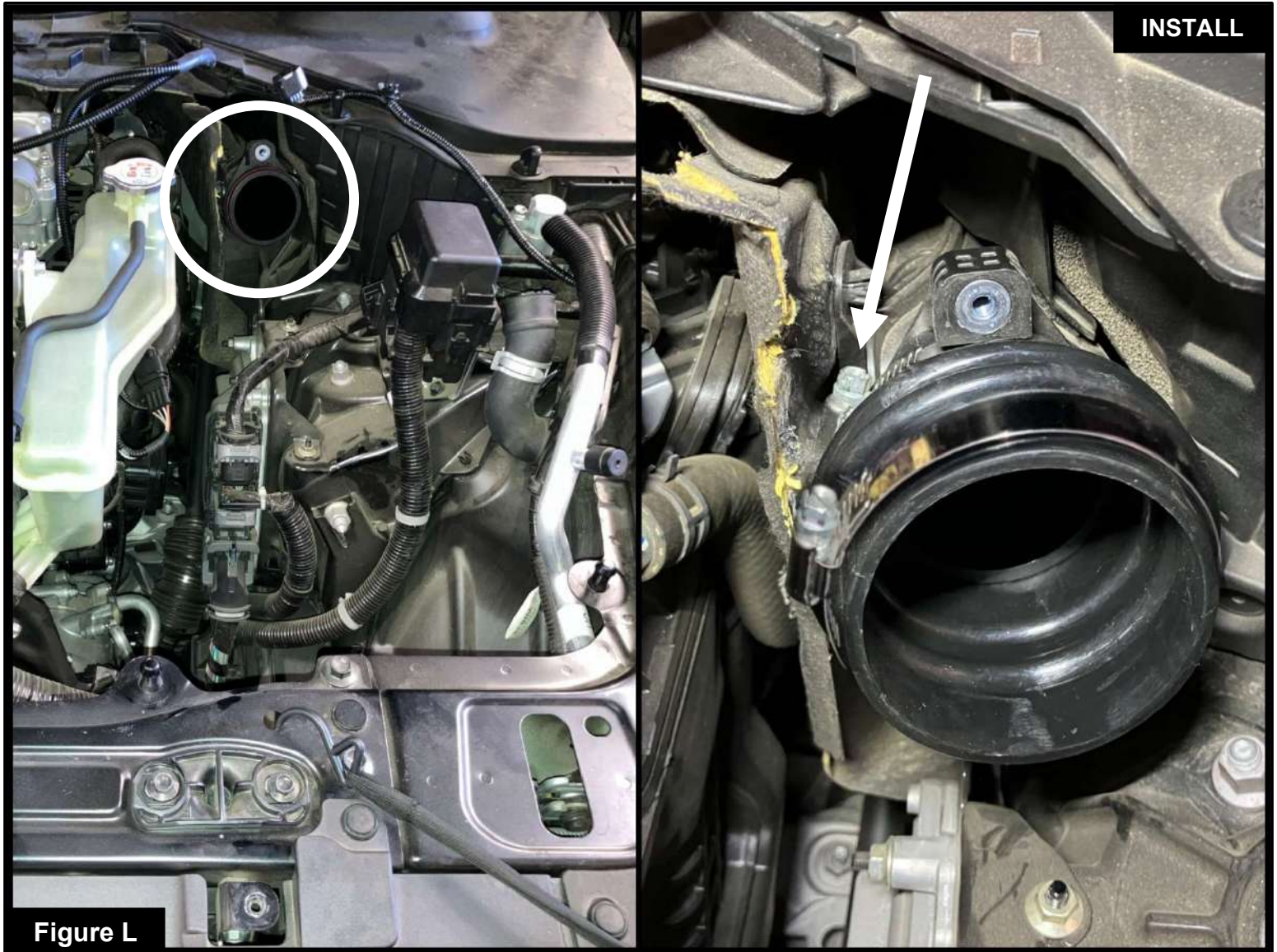

Figure L

**Refer to Figure L for Steps 14-15**

Step 14: Install the **aFe POWER** coupler with the **#44** & **#48** hose clamps, ensure the small side and **#44** clamp is facing the turbo inlet

Step 15: Use an 8mm driver or ratchet wrench to tighten the **#44** clamp. Do not tighten **#48** clamp at this time.



**Refer to Figure M for Step 16**

Step 16: Install the **TAKEDA** housing into the vehicle ensuring the bottom mounting stud snaps securely into the rubber grommet. Housing will be secured with screws later in the installation.



Figure N

**Refer to Figure N for Steps 17-19**

Step 17: Insert the **TAKEDA** tube into the filter first, then insert it to the **aFe POWER** coupler. Ensure everything is properly aligned.

Step 18: Use an **8mm** driver or ratchet wrench to tighten all clamps.

Step 19: Use a 10mm driver or ratchet wrench to install the (2) two screws removed in **STEP 6** in order to secure the **TAKEDA** housing



Figure O

**Refer to Figure O for Step 20**

Step 20: Use the supplied vinyl cap and mini hose clamp to seal the sound tube opening. If the sound tube was disconnected only from the intake tube side (**see STEP 3**), be sure to cap that opening.

**Note:** Certain trims may not have this sound tube. If absent, proceed to the next step.

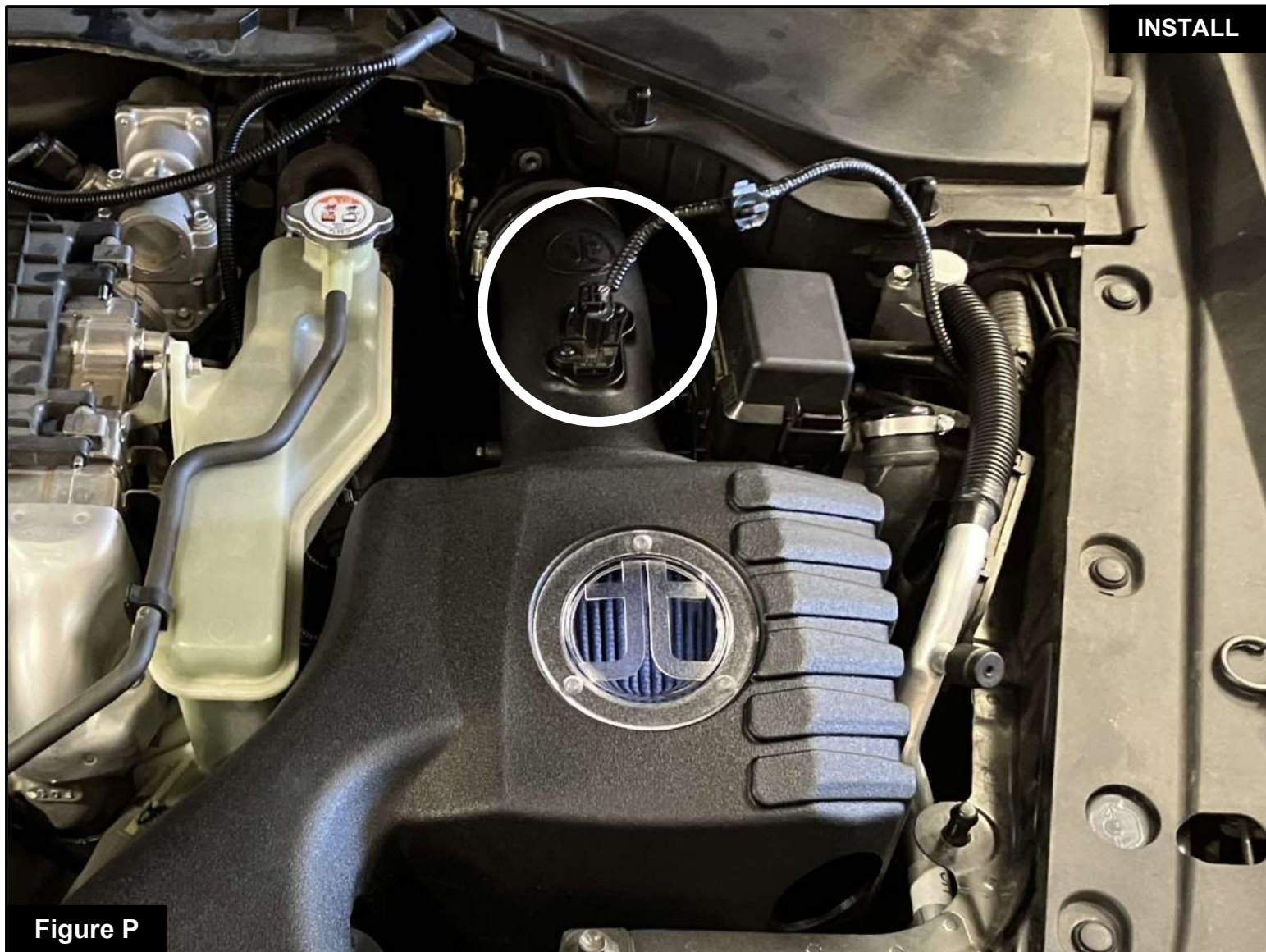

Figure P

**Refer to Figure P for Step 21**

Step 21: Connect the Mass Air Flow (MAF) sensor harness to the Mass Air Flow (MAF) sensor.

**Figure Q****Refer to Figure Q for Steps 22-23.**

Step 22: Release the engine cover anchor from the hood to lower the engine cover.

Step 23: Turn the locking tabs on the engine cover by hand to the lock position.

**Figure R**

**Refer to Figure R for Step 24.**

Step 24: Install the **TAKEDA** plug. The kit includes an optional plug to close off the auxiliary air inlet. •

- **Without the plug installed, the TAKEDA intake will capture the maximum amount of air available. More airflow can lead to increased power, but some of this air may come from inside the engine compartment and could be warmer, potentially affecting vehicle performance.**
- **Installing the plug on the housing will block out hot engine air, ensuring that only the coolest air is directed into the engine. This will also help reduce intake noise.**



**Your installation is now complete. Thank you for choosing TAKEDA USA!**

**NOTE: Check to ensure that all screws, clamps, and connectors are secure after 100-200 miles.**



PAGE LEFT BLANK INTENTIONALLY



***advanced FLOW engineering, inc.***

Corona, CA 92879

<https://afepower.com/contact-us>