

advanced FLOW engineering

Cold Air Intake System

Instruction Manual P/N: 50-70120KN

| | | | |
|-------------------|--------------------------------|------------------------|--------------------------------------|
| Make: RAM | Model: 1500 | Year: 2025-2025 | Engine: L6-3.0L(tt) Hurricane |
| Make: Jeep | Model: Grand Wagoneer | Year: 2022-2025 | Engine: L6-3.0L(tt) Hurricane |
| Make: Jeep | Model: Grand Wagoneer L | Year: 2023-2025 | Engine: L6-3.0L(tt) Hurricane |
| Make: Jeep | Model: Wagoneer | Year: 2023-2025 | Engine: L6-3.0L(tt) Hurricane |
| Make: Jeep | Model: Wagoneer L | Year: 2023-2025 | Engine: L6-3.0L(tt) Hurricane |

(Fit on both the Standard Output (SO) and High Output (HO) engine)



- Please read the entire instruction manual before proceeding.
- Ensure all components listed are present.
- For technical support please call at 951-493-7185.
- Ensure you have all necessary tools before proceeding.
- Do not attempt to work on your vehicle when the engine is hot.
- Retain factory parts for future use.

| Label | Qty. | Description | Part Number |
|-------|------|--|--------------|
| A | 1 | Air Filter (Black Pro 5R) for 50-70120KN | 20-91209K |
| B | 1 | Tube, mounted on the engine | 05-5070120N1 |
| C | 1 | Tube, with sensor pad | 05-5070120N2 |
| D | 1 | Housing with sight window | 05-5070120N3 |
| E | 1 | Coupler, Bellow: 4-1/4" ID | 05-01430 |
| F | 1 | Coupler, Reducer: 4-1/4" to 4" ID | 05-01768 |
| G | 1 | Plug, for housing auxiliary inlet | 05-01429 |
| H | 3 | Worm Clamp, #072 | 03-50010 |
| J | 1 | Worm Clamp, #064 | 03-50006 |
| K | 2 | Screw, Torx: M4 x 10mm | 03-50490 |
| M | 1 | Bumper, Rubber: 1/2" ID x 1" OD | 03-50769 |
| N | 2 | Cable holder for 7/16" Diameter | 05-01770 |

Installation will require the following tools:

8mm nut drivers or socket, 10mm,13mm sockets and ratchet, 6" extension, and T20 torx bit, Adjustable wrench.

Warranty information available at <https://afepower.com/warranty>

Emissions Disclaimer:

This product is not currently CARB exempt and is not available for purchase in California or for use on any vehicle registered with the California Department of Motor Vehicles.

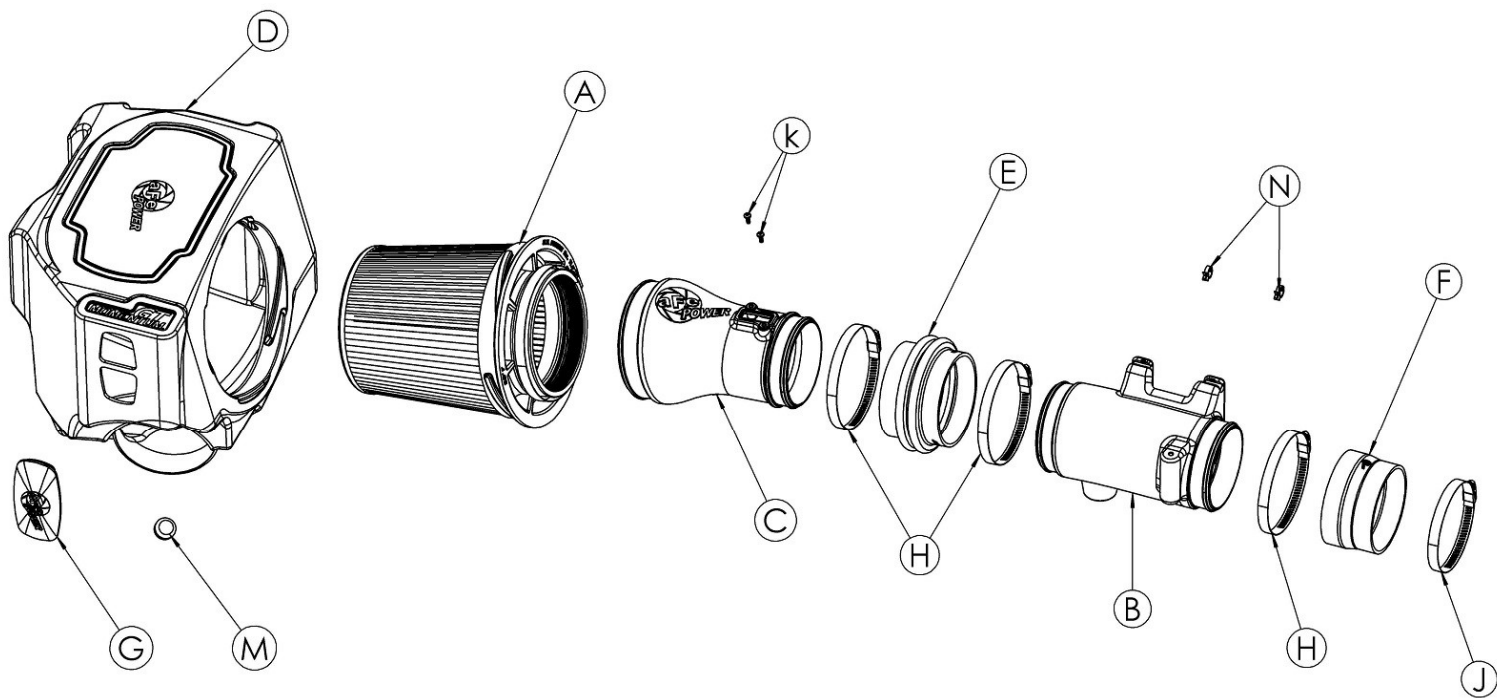

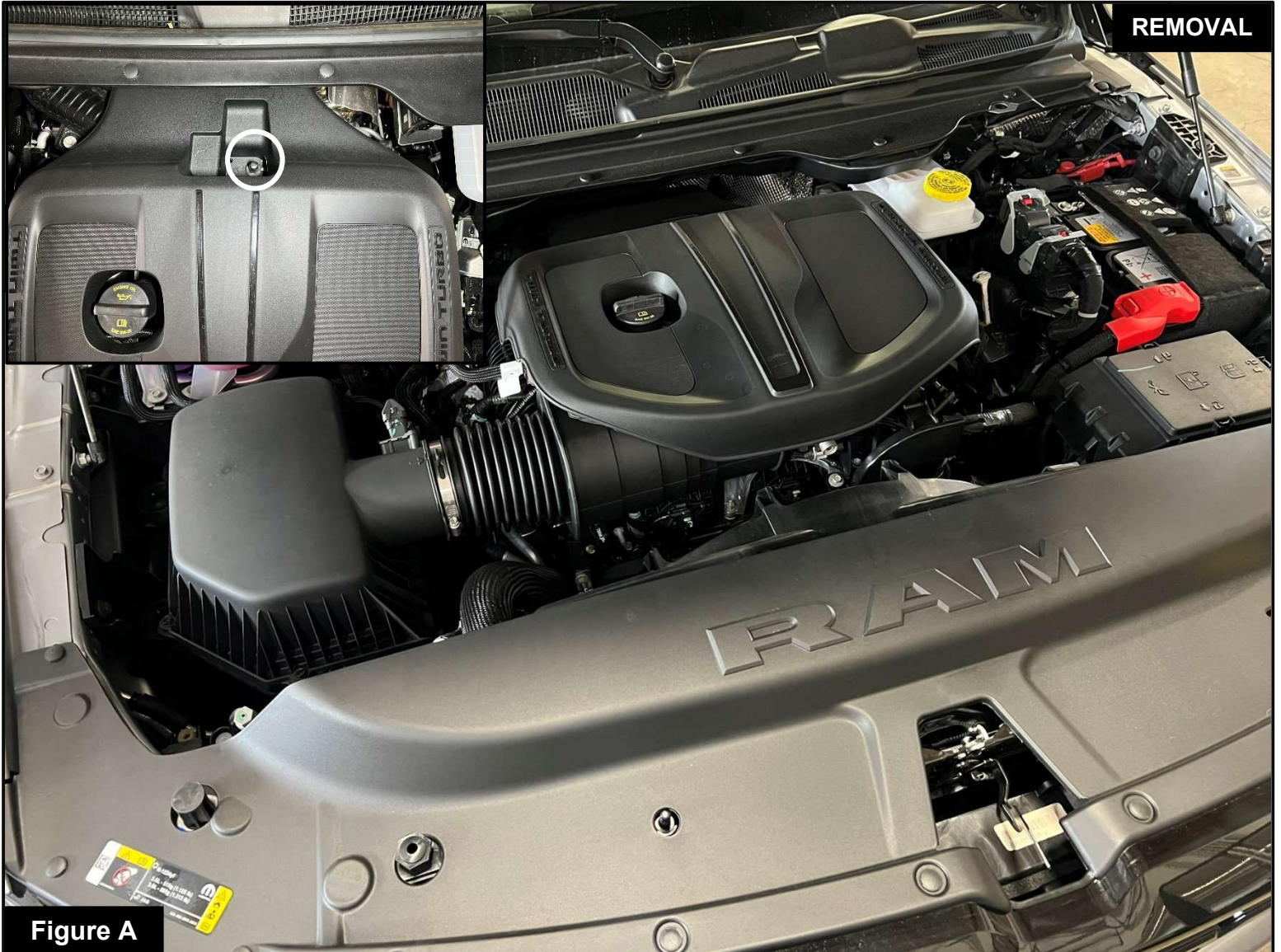
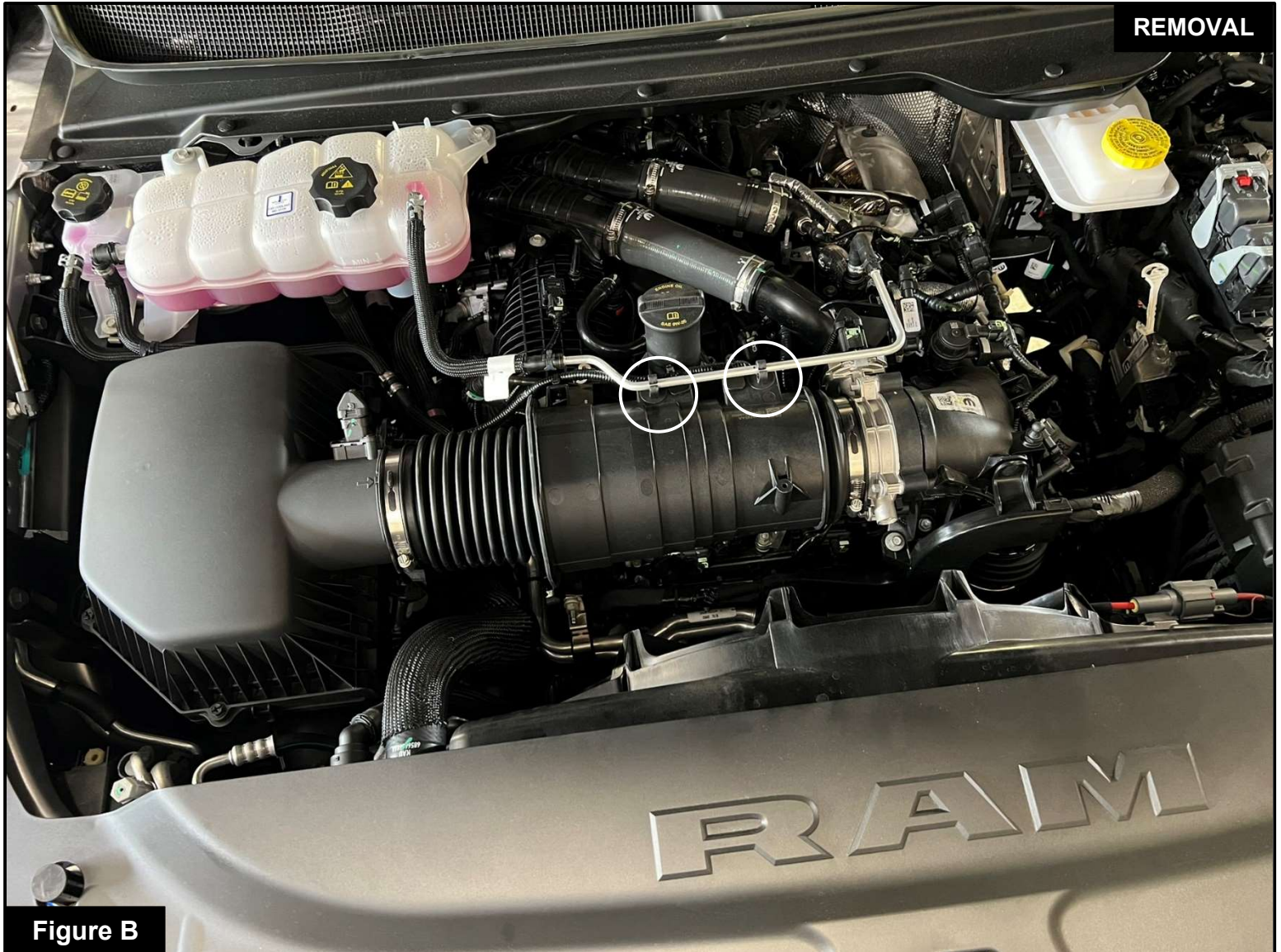

Figure A

Refer to Figure A for Steps 1-2

Step 1: Using a 13mm socket and ratchet, remove the nut securing the engine cover.

Step 2: Remove the engine cover.



Refer to Figure B for Step 3

Step 3: Carefully release the coolant line from the retaining clips and tuck it behind the oil filler neck to keep it out of the way. It will get mounted onto the aFe POWER tube.



Figure C

Refer to Figure C for Step 4-5

Step 4: With a plastic pry tool or trim removal tool, gently pop out the four retaining clips that hold the Mass Air Flow (MAF) sensor harness in place, tuck the harness behind the oil filler neck to keep it out of the way. Be careful not to damage the wiring.

Step 5: Push the locking clip outward, then press down on the release tab to disconnect the MAF sensor connector.

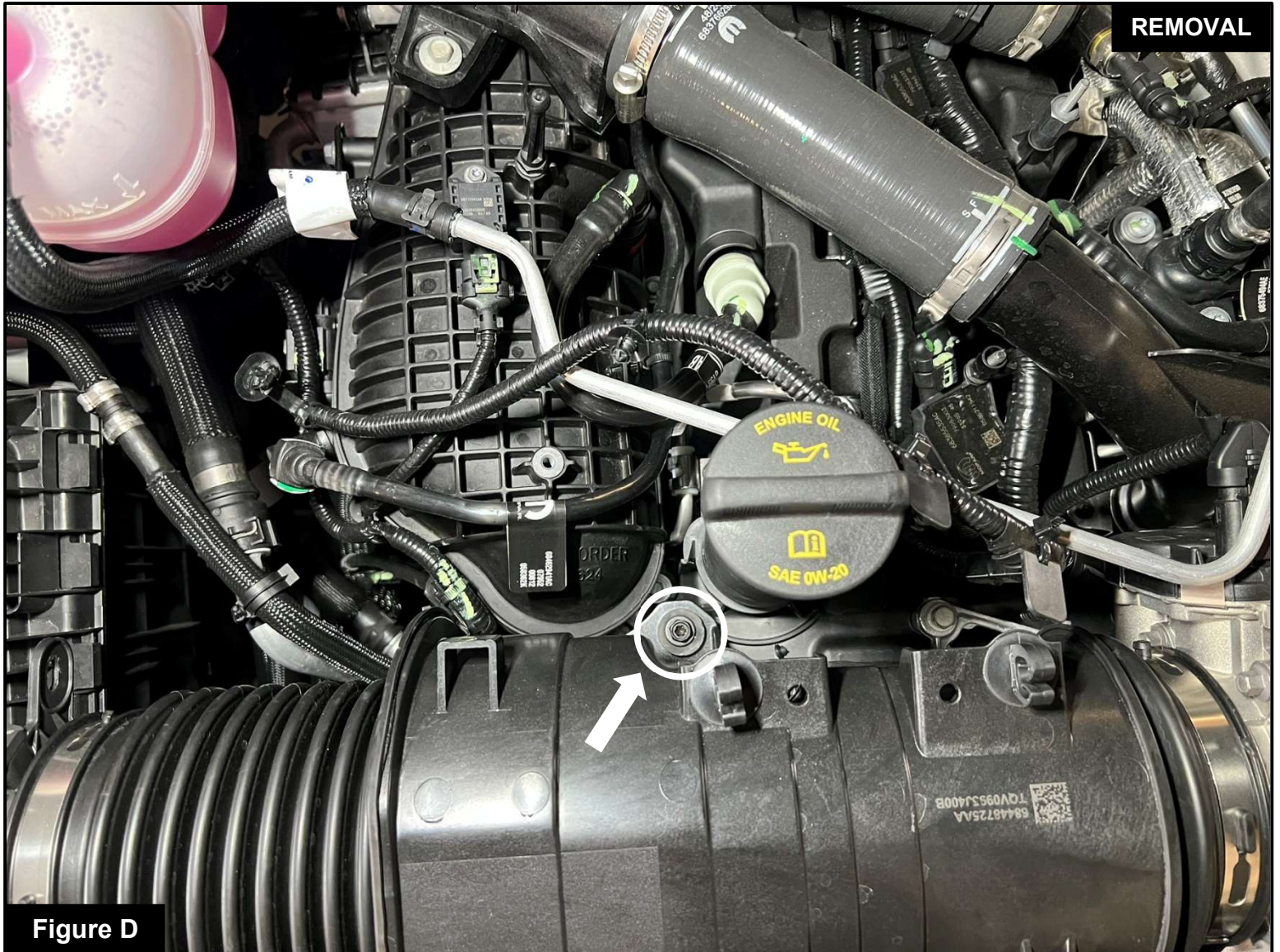
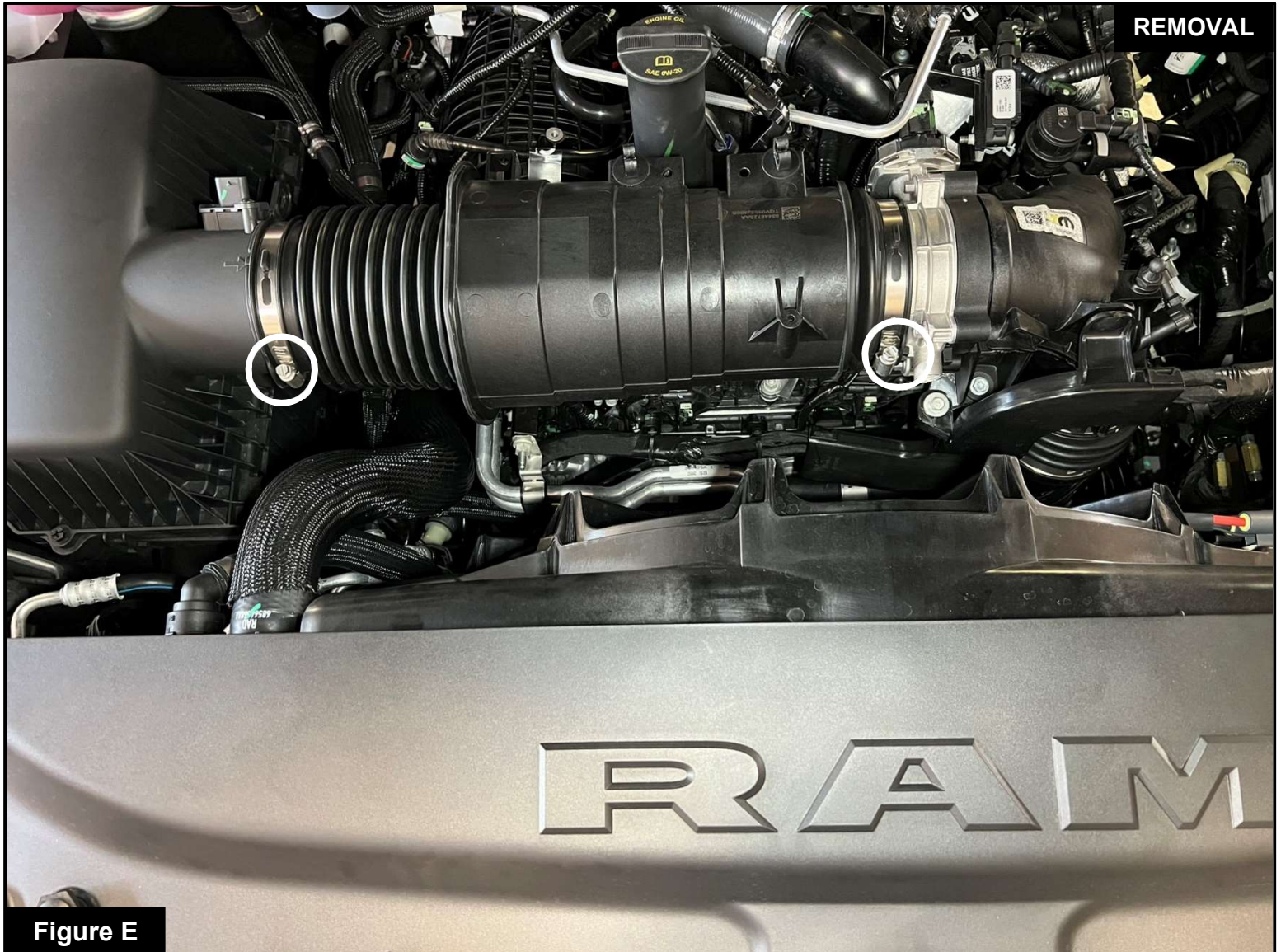

Figure D

Refer to Figure D for Step 6

Step 6: Using a 10mm socket with an extension and a ratchet, remove the screw securing the intake tube to the vehicle. Screw will be reused later in the installation.



Refer to Figure E for Step 7

Step 7: Using an 8mm nut driver, loosen the clamps securing the intake tube to the throttle body and airbox.

Once loosened, carefully remove the intake tube by sliding it off both sides.



Refer to Figure F for Step 8

Step 8: Firmly grasp the airbox and pull straight up to release the grommets from the mounting pegs. Lift the airbox out of the vehicle.

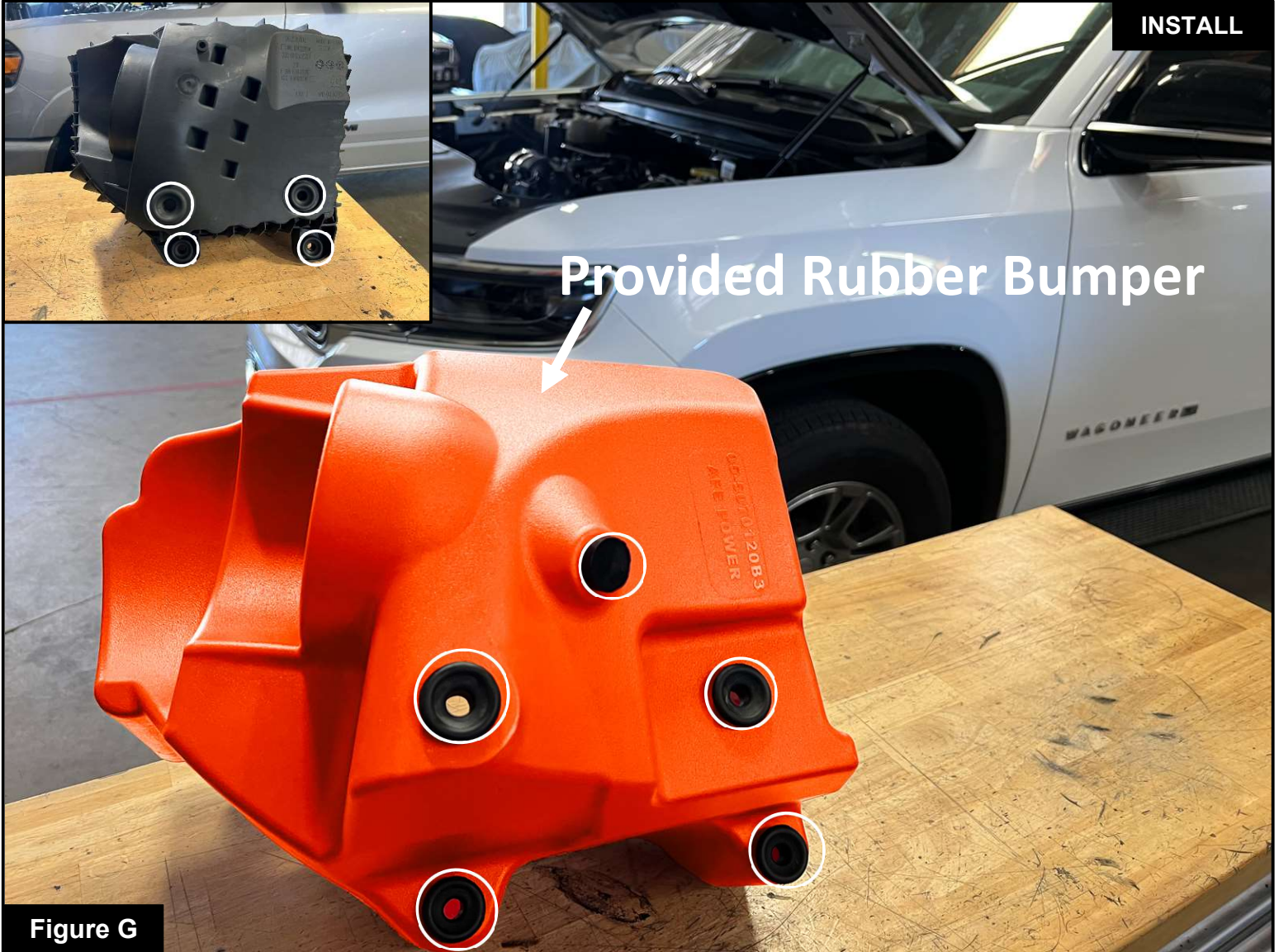

Figure G

Refer to Figure G for Steps 9-10

Step 9: Carefully transfer the factory grommets from the original airbox to the aFe POWER housing, ensuring they are properly seated for a secure fit.

Step 10: Add the provided rubber bumper to the last hole on the aFe POWER housing.



Figure H

Refer to Figure H for Step 11

Step 11: Install the aFe POWER housing assembly into the vehicle, aligning the grommets on the housing with the factory mounting pegs. Press down firmly to sit the housing securely.



Figure I

Refer to Figure I for Step 12

Step 12: Install the air filter into the aFe POWER housing and rotate it clockwise until it fully locks into place.

Pull on the filter gently to ensure it is properly seated.

**Figure J****Refer to Figure J for Steps 13-15**

Step 13: Remove the metal sleeve from the smaller grommet on the factory intake tube, then transfer the grommet to the aFe POWER intake tube that is going to be mounted on the engine.

Step 14: Transfer the larger grommet from the factory intake tube to the aFe POWER intake tube. Make sure it is fully seated and aligned properly.

Step 15: Install the two provided cable holders into the aFe POWER intake tube, press them firmly into place as shown.

**Figure K****Refer to Figure K for Step 16**

Step 16: If your vehicle has the engine cover mounting peg on the factory tube, using an adjustable wrench, carefully remove it. Then screw it onto the hole on the aFe POWER intake tube. If your vehicle does not have that peg, you can skip this step.



Refer to Figure L for Step 17

Step 17: Use a T20 Torx driver to remove the MAF sensor from the factory airbox. Carefully transfer the sensor to the aFe POWER intake tube and secure it using the provided T20 screws.

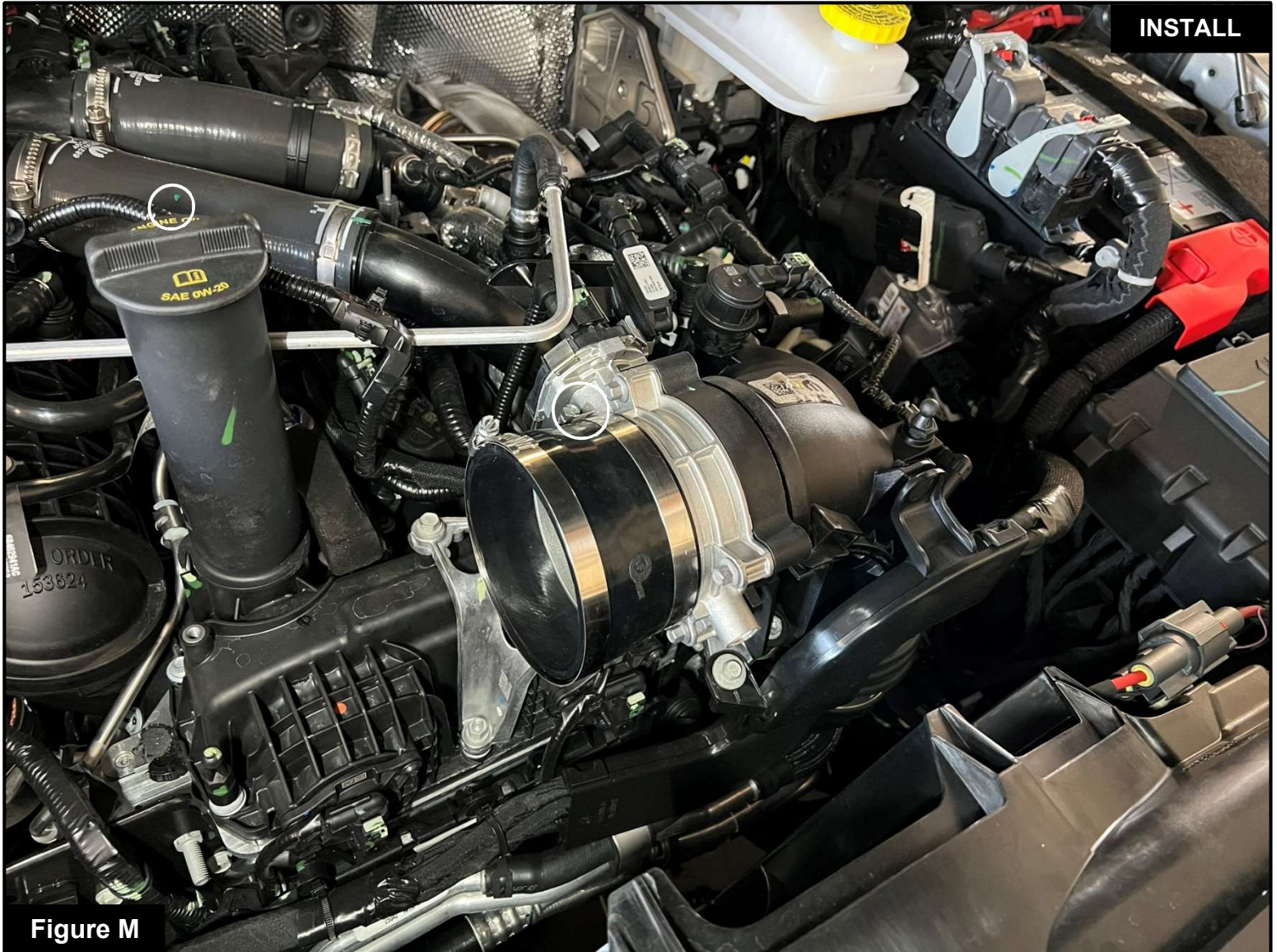

Figure M

Refer to Figure M for Step 18

Step 18: Install reducer coupler with the smaller end positioned over the turbo inlet. Use the provided #64 clamp to secure the coupler to the turbo inlet using an 8mm nut driver. Then, loosely slide a #72 clamp over the larger end of the coupler. Do not tighten clamp at this time.



Figure N

Refer to Figure N for Steps 19-20

Step 19: Slide the aFe POWER intake tube into the open end of the coupler, ensuring it sits fully. Then, press down on the tube so the grommet aligns and sits securely onto the factory mounting peg. Tighten the clamp to secure the intake tube.

Step 20: Use a 10mm driver or ratchet wrench to install the screw that was removed on **Step 6** to secure the intake tube.



Figure O

Refer to Figure O for Step 21

Step 21: Pre-install the two #72 clamps onto each end of the bellow coupler. Then, slide the coupler onto the end of the intake tube.



Figure P

Refer to Figure P for Step 22

Step 22: Install the intake tube with the sensor by first sliding it into the coupler, then into the air filter.

Ensure both ends are fully seated, and make sure the MAF sensor is pointing straight up. Once properly aligned, tighten all clamps securely using an 8mm nut driver.

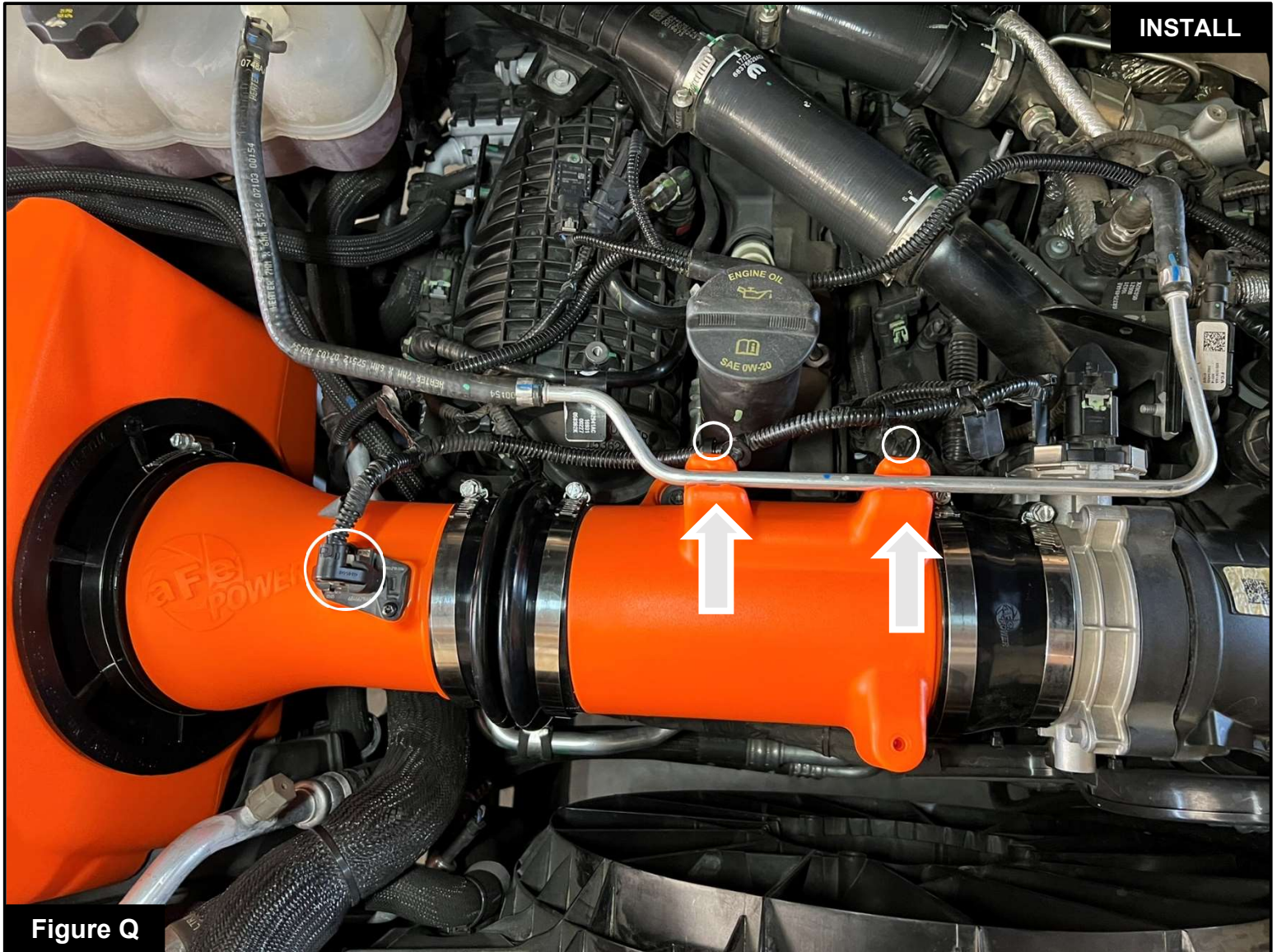

Figure Q

Refer to Figure Q for Steps 23-24

Step 23: Secure the MAF sensor harness onto the clips installed on **Step 14**, then reconnect the harness to the MAF sensor by pressing the connector in until it clicks.

Step 24: Clip the coolant line onto the intake tube.



Figure R

Refer to Figure R for Step 25

Step 25: The kit includes an optional plug to close off the auxiliary air inlet. If desired, Install the aFe POWER plug onto the housing:

- Without the plug installed, the aFe POWER intake will capture the maximum amount of air available. More airflow can lead to increased power, but some of this air may come from inside the engine compartment and could be warmer, potentially affecting vehicle performance.
- Installing the plug on the housing will block out hot engine air, ensuring that only the coolest air is directed into the engine. This will also help reduce intake noise.



Refer to Figure S for Step 26

Step 26: Install the engine cover and secure it using the nut that was removed on **Step 1**.

Your installation is now complete. Thank you for choosing aFe POWER!

NOTE: Check to ensure that all screws, clamps, and connectors are secure after 100-200 miles.



Page left blank intentionally.



advanced FLOW engineering, inc.

Corona, CA 92879

<https://afepower.com/contact>