

2019+ DODGE RAM 3500 8" LIFT KIT

PART# 54417

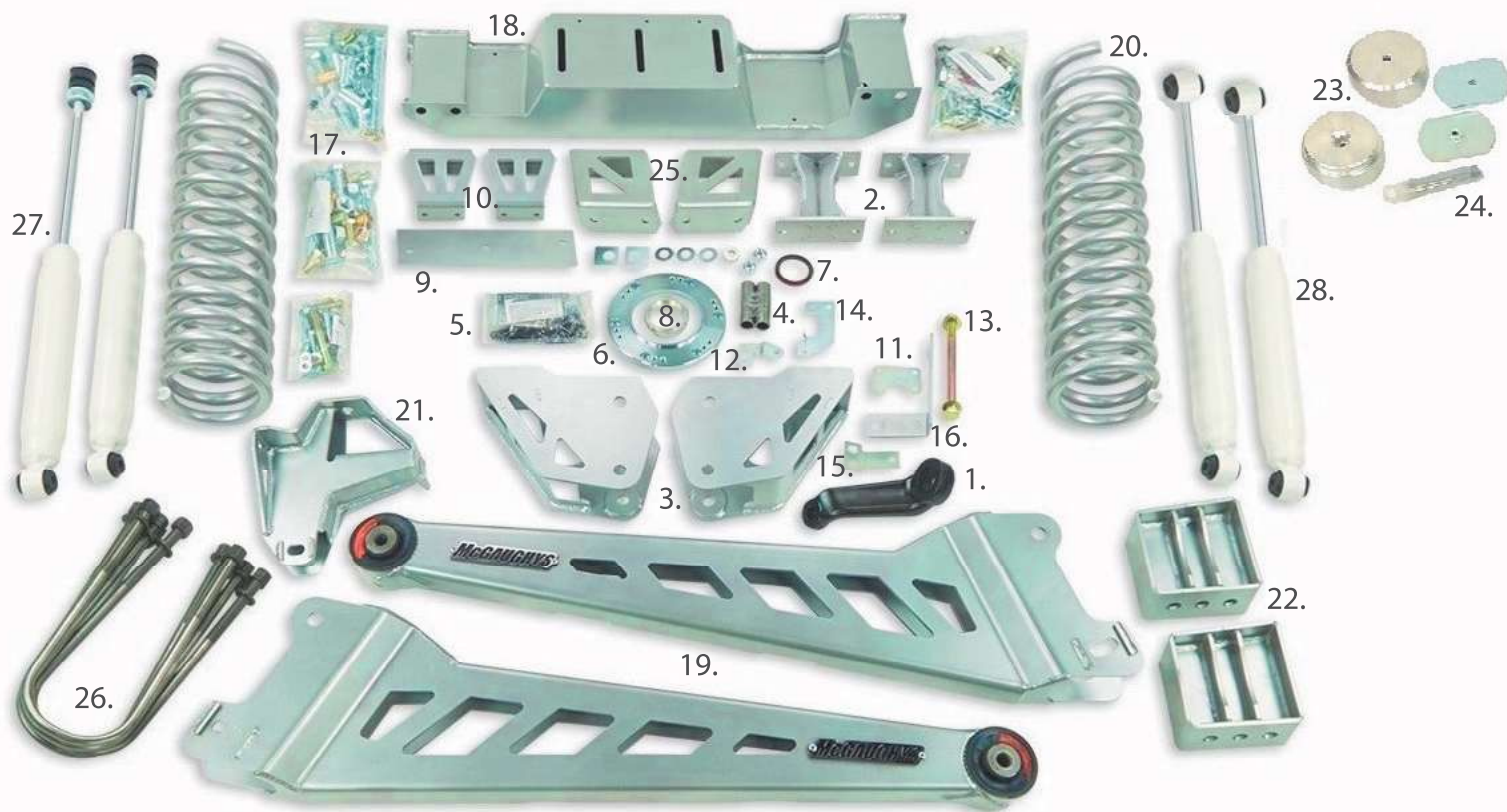

- | | |
|---|---|
| 1. Drop Pitman Arm | 16. Wire Loom Relocation Bracket |
| 2. Rear Bump Stop Extenders (2) | 17. Hardware Packs (3) |
| 3. Radius Arm Drop Brackets (2) | 18. Transmission Crossmember |
| 4. Radius Arm Drop Bracket Sleeves (2) | 19. Radius Arms (2) |
| 5. Reclocking Ring Hardware | 20. Front Coil Springs (2) |
| 6. Transmission Reclocking Ring | 21. Front Track Bar Drop Bracket
w/ Cam Washers (2) |
| 7. Transmission Output Shaft Seal | 22. Rear Lift Blocks (2) |
| 8. Transmission Output Shaft Seal Extension | 23. Front Coil Retainer Billet Pucks (2) |
| 9. Transmission Shim | 24. Front Coil Retainer Nut Brackets (2)
w/ Hardware |
| 10. Front Bump Stop Extenders (2) | 25. Front Sway Bar Drop Brackets (2) |
| 11. Rear Brake Line Bracket (2019-2024) | 26. Rear U-Bolts (4) |
| 12. Front Brake Line Bracket (Driver Side) | 27. Front Shocks (2) |
| 13. Transmission Bolt | 28. Rear Shocks (2) |
| 14. Front Brake Line Bracket (Pass. Side) | |
| 15. Rear Brake Line Bracket (2013-2018) | |



559-226-8196
4603 E. VINE AVE.
FRESNO, CA 93725
www.mcgaughys.com

**READ THESE ENTIRE INSTRUCTIONS
BEFORE STARTING ANYTHING**

- If you are the installer only, and not the owner of the vehicle, please make sure the owner of the vehicle gets these instructions. They contain very important information about the lift kit, maintenance, and warranty.

-Before moving forward with installation, please layout all parts from boxes and ensure everything is present. If any parts are missing, please contact McGaughy's Suspension immediately at 559-226-8196.

-If you alter the finish of any of the provided components, like zinc plating, chroming, or powder-coating, which can cause damage to the strength and structure of the metal, any warranties will be null and void.

-If any components are ground on or modified in any way, then no returns or exchanges will be accepted and any warranties will be null and void.

-NO welding is required to install any part of this lift kit. Do not weld any components.

-Over-sized tires and heavier wheels can cause premature wear on factory and aftermarket components like ball joints, bushings, tie-rod ends, wheel bearings, idler arms, drive-lines, etc.... You may need to replace / install new components sooner than factory recommendations based on the tires and wheels you choose. Please note that the heavier and wider wheels and tires combined with aggressive driving (off-road and on highways) will cause more wear on ALL moving parts, factory and aftermarket. Especially when vehicle is in 4wd or Auto-4wd / AWD modes.



559-226-8196
4603 E. VINE AVE.
FRESNO, CA 93725
www.mcgaughys.com

WARRANTY INFORMATION

-McGaughy's warrants all **McGaughy's** products against manufacturer's defects in materials or workmanship for a period of **ONE-YEAR** from the date of original purchase. All McGaughy's spindles carry a **LIFETIME** warranty against manufacturer's defects.

-Warranty will not extend to any product or part there in, that has been improperly installed, abused, or neglected

-McGaughy's will not warranty any product(s) that were modified in any way. Check fit all products prior to custom painting, powder-coating, or any form of fabrication (sanding, drilling, painting, chroming, etc).

-There are **NO WARRANTIES** neither expressed nor implied for powder-coating on any McGaughy's products.

-McGaughy's is not responsible for damages and/or warranty of other vehicle parts (factory or aftermarket) related or non-related to the install of McGaughy's component(s).

-Warranty is limited to the repair or replacement (of McGaughy's product only), at McGaughy's discretion. And only after inspection of the defective part, once returned to McGaughy's with proof of purchase, date of purchase, and all shipping costs prepaid.

-Any cost of labor, freight, incidental or consequential damages are expressly excluded from warranty.

FRONT INSTALLATION

Before starting this installation, we recommend loosening the factory front shocks with the truck on the ground. Once the vehicle is in the air, it is extremely difficult to access the upper shock nuts and they have a significant amount of tension on them. Loosen the top nut using a 21mm wrench, but DO NOT remove it all the way off since it holds up the front suspension. (pic 1) Always use the proper tools and consult the factory service manual for torque values and procedures. With the vehicle turned off and the parking brake set, secure the rear wheels/tires with wheel chocks. Use a jack and lift the front of the vehicle. Place jack stands under the frame on both side of the vehicle. Remove the front wheels.

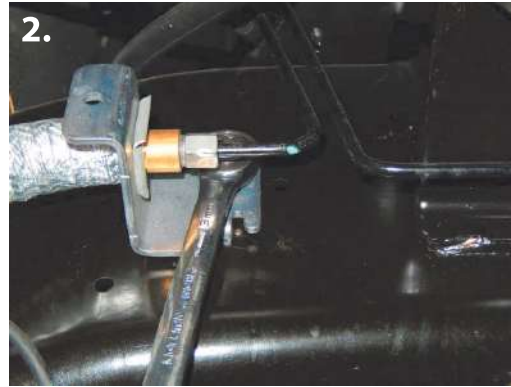

1. Using a 13mm wrench, unbolt the brake line brackets from the frame on both sides. (pic 2) Be sure to unbolt the brake line bracket from the axle for extra maneuverability.

2. Support the front drive line and remove the four front drive shaft flange bolts using a 15mm socket. (pic 3)



3. Remove the driver side drag link to pitman arm nut using a 21mm socket. Use a tie-rod removal tool to avoid damaging the factory tie-rod ends. (pic 4)

4. Remove the pitman arm to steering box nut using a 46mm socket. (pic 4)

5. Using a pitman arm puller, remove the pitman arm from the steering box output shaft. (pic 6)

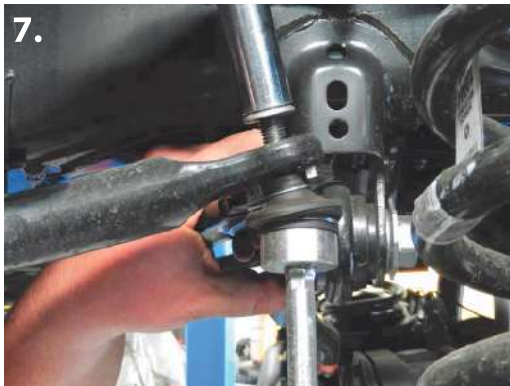

6. Remove the sway bar end link top nut on both sides using a 18mm socket. Separate the sway bar from the end links. (pic 7)

7. Remove the sway bar mount from the frame on both sides using a 15mm socket. (pic 8)

8. Remove the track bar using a 27mm socket.

9. Support the front axle and remove the front shock top nuts.

10. Remove the front shock lower mounting bolts using a 21mm socket. Remove the shocks from the vehicle. (pic 9)



11. Slowly lower the front axle until the front coil spring tension is released.



12. Remove the factory front coil springs. (pic 10)

13. Unbolt the factory front track bar mount using a 21mm socket. (pic 11-12)

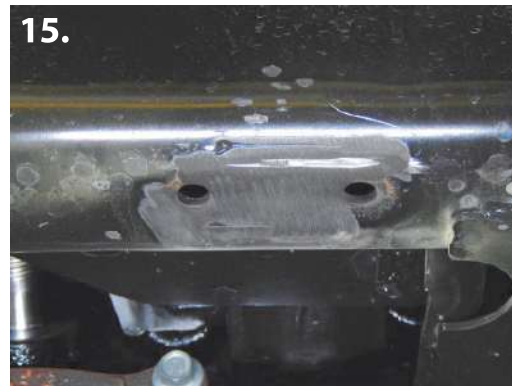

14. Remove the factory radius arms. Use a 27mm socket on the upper arm to axle bolts and a 24mm socket on the lower arm to axle bolts. Use a 27mm socket on the arm to frame bolts. (pic 13)

15. Use a cut-off wheel to remove the front bump stop mounts on both sides of the frame. The mounts will be reused, so do not destroy them. Cut the factory weld only. (pic 14)

16. Clean the remaining weld material from the frame using an abrasive disc or flap wheel. Be sure to paint the bare metal. (pic 15)



17. Use the provided tap on the existing holes that were located under the factory bump stop mount on the frame. (pic 16)

18. Clean the remaining weld material from the factory bump stop cup that was removed from the frame using an abrasive disc or flap wheel. Be sure to paint the bare metal.

19. Install the factory bump stop cups onto the new bump stop drop brackets using the provided 3/8" allen bolts.

20. Install the original bump stops back into the cups by pressing them in. This will take some force. (pic 17)

21. Now install the bump stop brackets using the provided 7/16" x 3/4" bolts into the holes you tapped. (pic 18)



22. Install the new track bar drop bracket using the original hardware. Place the 3 provided laser cut 16g washers on top of the new bracket over the original bolts before installing into the original location. (pic 19-20)

23. Use the last two original bolts on the side of the frame going into the new drop bracket. Use the provided 14mm lock nuts. (pic 21)

24. Now tighten all five bolts on the new track bar drop bracket in order of installing. First being the single bolt on the back side in pic #19. Then the two bolts on the front in pic #20. And last the two on the side of the frame in pic #21. Torque all to factory specs.



25. New radius arm drop dow brackets will slip over the outside of the original radius arm mount on the frame. Use the provided spacer and place it in between the original radius arm mount. Use the provided 18mm x 130mm bolt (pic 22)

26. With the radius arm drop bracket held in place, mark the two holes on the underside of the frame. You can use a 1/2" drill bit to mark both holes to keep them centered. Once both holes are marked, remove the radius arm drop bracket and drill both holes to 11/16". Use the provided rivet tool to install frame rivets. Two per side. (pic 23-24)

**HOLES MUST BE EXACTLY 11/16", NO LARGER
OVER-SIZED HOLE WILL CAUSE THE RIVET NUT TO PULL BACK THROUGH THE FRAME**



27. Reinstall the radius arm drop brackets over the original mount. Install the sleeve spacer and use 18mm x 130mm bolt to mount. Now use the provided 1/2"-13 x 1-1/4" bolts into the rivet nuts installed into the frame. Torque these two bolts first, to 70 lbs. Next torque the bolt going through the sleeve to 90 lbs. (pic 25-26)

28. Attach the new radius arm to the radius arm drop bracket using the provided 18mm x 130mm bolt. (pic 27)



28.



29.

29. Attach the front of the new radius arms at the axle using the factory hardware. Be sure to set the cam bolts the same on both sides. Torque to factory specs. (pic 28-29)

30. Do not tighten the bolts on the radius arms at the frame side yet. Leave those until truck is on the ground. Then they can be tightened and torqued to the factory specs.



30.

FRONT VIEW



31.

REAR VIEW



32.

31. Track bar alignment cams must be used in the position shown. (pic 30-31) Place cams in front and back side of track bar drop bracket, so that the bolt will pass through with no obstruction.

32. Install the factory track bar into track bar drop bracket using the supplied 18mm x 90mm hardware. Torque to factory specs. (pic 32)

***** Before moving forward, Please refer to coil retainer instructions.*****

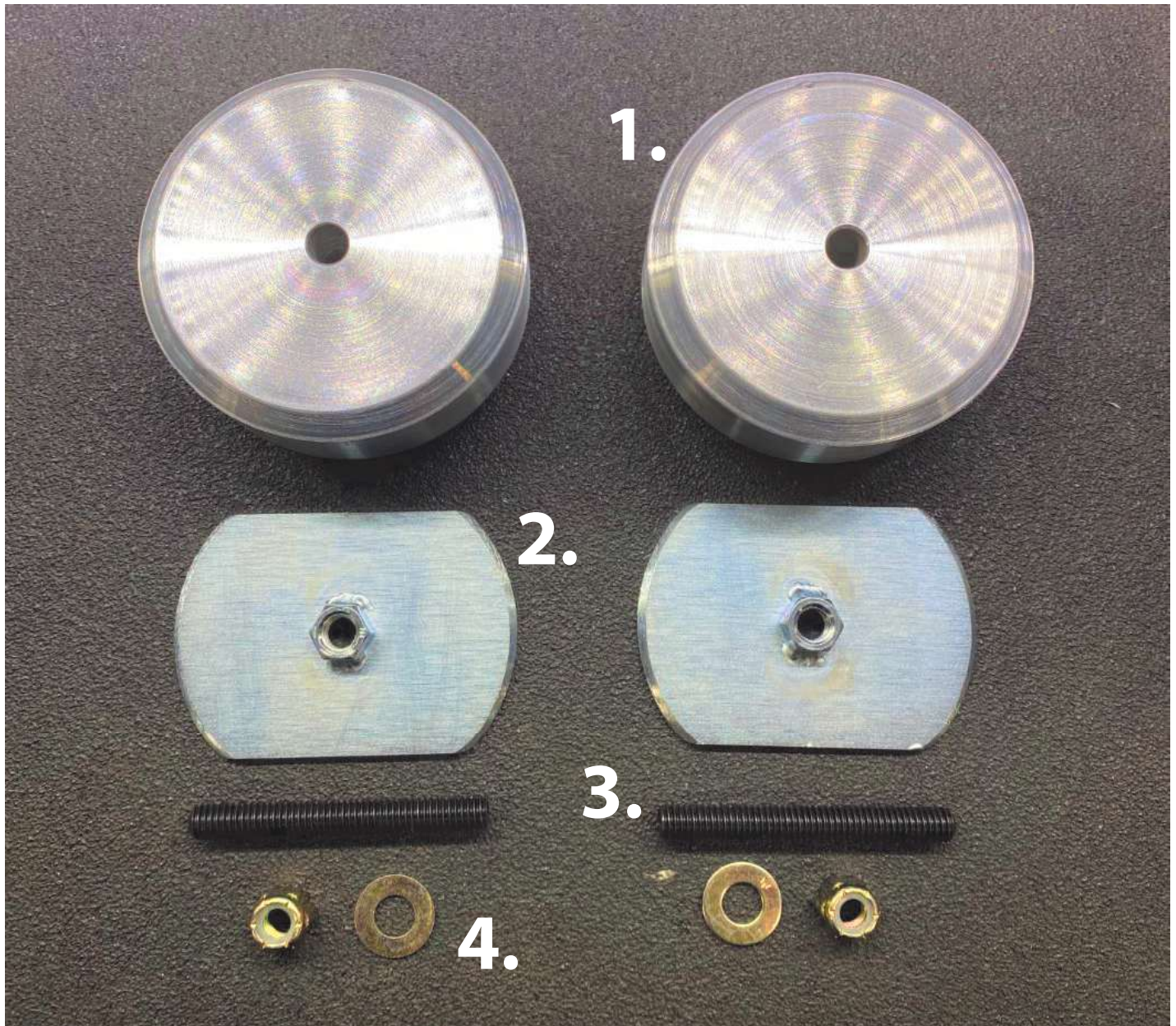

Kit Includes:

1. Coil Retainer Billet Pucks (2)
2. Retainer Backing Plate (2)
3. Retainer Bolt (2)
4. Hardware - Lock Nut (2) / Washer (2)



1. First apply loctite to the supplied retainer bolt. Then screw bolt into the retainer backing plate. Make sure bolt is flush with the top of the welded nut only. Do not screw the bolt past the backing plate.



2. Next, insert the backing plate with bolt into the opening on the factory upper coil mount.



6.



3. With the backing plate installed, slide the supplied billet coil retainer puck in place. Make sure the billet puck slides into place in the opening on the mount. You may need to clean the edges of the opening with a file or sand paper, to be sure a nice tight fit. Then use the supplied washer and lock nut to install. Use an allen wrench and a 9/16" wrench to tighten to 20 ft/lbs.

4. Now re-install the factory coil isolator into the factory location.

5. Repeat these steps for the opposite side of the vehicle.

Now with the coil retainer pucks installed, you can now install the new provided lift coils.

DO NOT install front coils without having the billet coil retainer pucks installed.



33. Install new lift coils. Be sure to use the factory coil isolators in the factory locations. The tighter winding face up and the more open windings face down. (pic 33-34)

34. Install the new shocks into the factory location using the factory hardware on the lower mount and the provided hardware for the upper mount. (pic 35)



35. Redirect brake line, so that passenger side brake line bracket faces down instead of to the rear. (pic 36)

36. Install supplied brake line drop brackets on the frame using the factory hardware. Then install the factory brake line bracket to the new drop down bracket using the supplied 5/16" x 3/4" hardware. (pic 37-38)

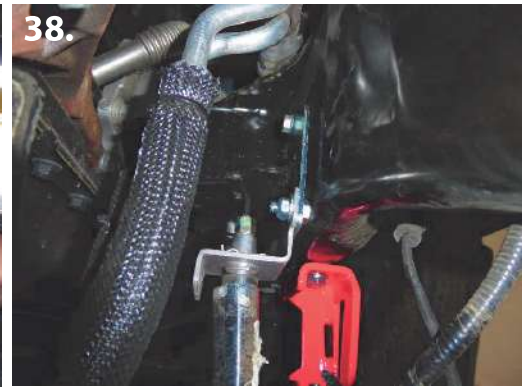

37. Repeat steps 35 and 36 for the driver side brake line bracket. (pic 39-41)

38. Make sure the factory brake line isn't rubbing against anything that could cause failure.

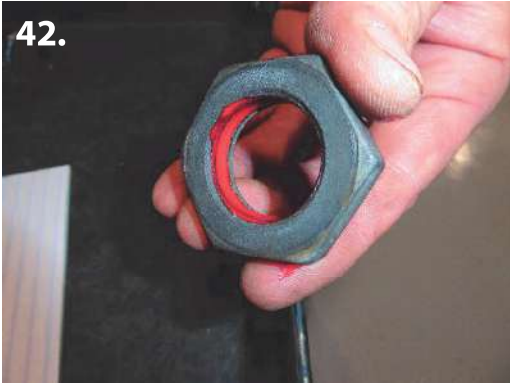

39. Before install new drop pitman arm, clean the factory splines and threads so there is no debris or oil. Be sure to clean the threads on the nut as well. Now apply the supplied red thread locker to the factory pitman retention nut and torque to factory specs. Make sure you install it the same way it came off the vehicle. Lining up the four alignment channels. (pic 42-43)

40. Using a 18mm socket, loosen the drag link clamp. (pic 44)





- 41.** Loosen and remove drag link adjuster (hex head nut between drag link clamp and tie rod) by turning the nut clockwise while holding the tie rod in place so not to spin. (pic 45)
- 42.** Make sure to note where the position of the tie rod is when removed from the drag link. (pic 46)
- 43.** Now remove the drag link adjuster from the tie rod. (pic 47)



- 44.** Once the drag link adjuster is removed, you must grind down flat the hexagon sides of the tie rod. Grind up to the threads. DO NOT grind any threads. When grinding the end of the tie rod, the goal is to extend the hexagon shaft right to the start of the threads. Making sure it is the same size from one end to the other. Be sure to stop right at the threads. You do not want to grind too much away. (pic 48-49)
- 45.** After grinding the tie rod sides flat, reinstall the drag link adjuster on to the tie rod. The tie rod must sit about 1/8" down inside the adjuster. (pic 50)



- 46.** Now install the tie rod into the drag link with the tie rod facing up. (pic 51)
- 47.** Once installed, tighten the drag link clamp. Torque to factory specs. (pic 52)



48. Mount the sway bar drop brackets on the frame in the factory locations. Use the factory hardware. Be sure to mount the brackets so that they are angled away from the axle. (pic 53)

49. Attach the factory sway bar to the drop down brackets using the supplied 3/8" x 1-1/4" hardware. (pic 54)

50. Now attach the sway bar end link in the factory location using the factory hardware. Torque to factory specs.

51. This kit requires a transfer case reclocking ring (included). You will need to remove the original transmission crossmember from the frame. Once you have supported the transmission, one of the bolts on the passenger side cannot be removed because it will hit the exhaust, it must be cut. Remove the nut and push the bolt back through, exposing the head of the bolt. Cut the head of the bolt off and pull it back through the opposite way. (pic 55) We provide you a new replacement bolt to use.

***** Before moving forward, Please refer to reclocking ring instructions.*****



52. Install the provided transmission shim before installing the new transmission crossmember. (pic 56)

53. Install the new transmission crossmember. Use the remaining three factory bolts and the one new bolt to replace the bolt that had to be cut. (pic 57)

54. Install wire loom relocating bracket on the driver side rear of transmission crossmember. Use the factory clip to hold the wire loom in place. The clip will snap into the new loom bracket. (pic 58) Torque all bolts to factory specs.



55. Make sure you open the factory clip inside the original driveline before installing it over the factory splines on the transfer case. Once the driveline is pushed all the way into place, the original clip will close locking on to the transfer case splines. Make sure you use the original rubber boot clamp from the transfer case to the driveline. This is to prevent debris from getting inside. (pic 59)

55. Apply the supplied thread locking compound to the driveshaft flange retaining bolts. Align the driveshaft flange to the axle flange and thread in the bolts. Torque to factory specs. (pic 60)

REAR INSTALLATION

With the vehicle turned off and the parking brake set, secure the front wheels/tires with wheel chocks. Use a jack and lift the rear of the vehicle. Place jack stands under the frame on both side of the vehicle. Remove the rear wheels.



1. Support the rear axle and remove the factory rear shocks.
2. Loosen one side of the vehicles's u-bolts, but do not remove. Then remove the u-bolts on th opposite side of the vehicle.
3. Before you drop the rear end, be sure not to over extend or stretch any lines or wires. (pic 1)
4. Install the new lift block and u-bolts on the ones side. Then install the block and u-bolts on the opposite side. Torque to 170 lbs. (pic 2-3) *Be sure to retorque after first 200 miles.
5. Install the provided rear brake line bracket onto the rear end in the factory location. Use the provide hardware to install the factory brake line bracket to the new brake line extension bracket. (pic 4)



6. Remove the factory bump stops on both sides using a 15mm socket.
7. Install the new rear bump stop extension to the frame on both sides using the factory hardware.
8. Mount the factory bump stops to the bump stop extensions using the provided 3/8" x 1-1/4" hardware. (pic 5)
9. Install the new rear lift shocks using the factory hardware. Be sure to have the shock body down. (pic 6-7)
10. You may now set the vehicle on the ground. If you have not already, be sure to tighten the rear track bar bolts.

Double check all the front and rear fasteners and components, making sure everything has been torqued to the proper specifications. This MUST be done prior to operating the vehicle. Be sure to get the vehicle properly aligned immediately. We recommend periodically checking all components front and rear to be sure they are all in proper working order.

DODGE RAM RE-CLOCKING RING INSTRUCTIONS
2014+ 2500 / 2013+ 3500 (for 6", 8", & 10")



1. Place a jack under the transmission pan.

2. Using a 15mm socket, remove the three nuts that hold transmission mount to crossmember. (pic 1)

3. Use a 15mm socket to remove the bolts that hold the driveline to the rear differential. (pic 2)

4. Remove rear driveline from the transfer case. Place a rag under the output shaft so any light oil can be captured. (pic 3)



5. Remove the eight Christmas tree clips on the wire that routes along the transmission crossmember. (pic 4)

6. Remove the 4 bolts that hold the transmission crossmember to the frame, using a metric 24 socket and wrench. (pic 5)

7. Remove the transmission crossmember from the vehicle. (pic 6)



7.



8.

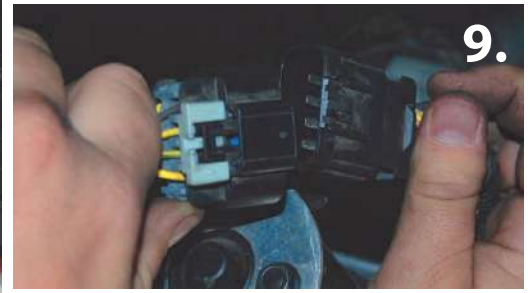

9.

8. Remove the front drive line bolts from the transfer case using a 5/8" wrench. Remove the drive line from the vehicle using a 15mm socket. (pic 7)

9. Remove the rubber transmission mount from the transmission using a metric 15 socket. (pic 8)

10. Unplug the electrical connector on the transfer case. (pic 9)



10.



11.



12.

11. Remove the 3 Christmas tree clamps that hold the wire to the transfer case. (pic 10) And disconnect the vent tube using pliers.

12. Using a metric 14 wrench, remove the six nuts that hold the transfer case to the transmission. (pic 11)

13. Using an inverted torque, remove the factory studs from the transmission case and discard. You can use pliers if you do not have an inverted torque. (pic 12)



13.



14.



15.

14. Take the index ring and locate the position where the bolt pattern matches up to the transfer case. (pic 13)

15. Using the provided metric 10-1.5 x 25mm SNCS bolts, tighten the ring to the transfer case. Apply a small amount of loctite to the bolts and tighten using a 8mm allen wrench. (pic 14)

16. Install the supplied 3/8"-24 x 2" S.S. screw using a 3/16" allen wrench. Apply a small amount of loctite to each screw. Be sure to only screw in until it touches, then put a small amount of pressure to tighten.



NOTE: Picture 16 shows in the **recommended** 20 degree position. You will need to install the McGaughy's transmission crossmember in this position. Picture 17 shows the 10 degree position, which can run the factory crossmember with trimming.

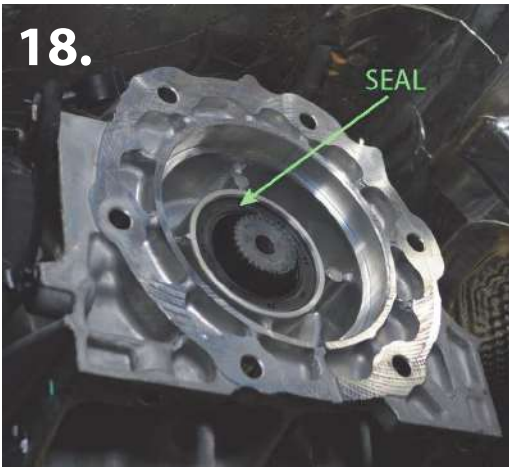

17. Remove the output shaft seal on the transmission and discard the factory seal. (pic 18)

18. Using a bearing race and seal driver, install the oil seal into the seal adaptor. (pic 19)

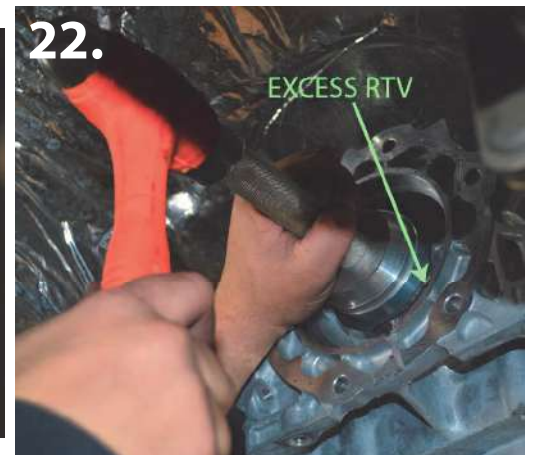

19. After the seal is installed, apply a small amount of RVT silicon to the seal adaptor. (pic 20) Also, apply a small amount of grease to the seal. (pic 21)

20. Tap the seal adaptor into the transmission where the factory seal was, using a bearing race and seal driver. Remove any excess RTV silicon. (pic 22)

BE SURE TO LET SILICON SET FOR 24 HOURS BEFORE DRIVING



21. Reinstall the transmission case to the transmission, using a 9/16" wrench and socket. Torque to factory specs. (pic 23)

22. Reconnect the vent tube to the vent port. Reinstall the electrical connector with the three Christmas tree clamps.

23. Reinstall the rubber transmission mount. Torque to factory specs. (pic 24)

24. Reinstall the front drive line. (pic 25)

25. If your kit came with a drive line spacer, install it now using the supplied 7/16" x 2" bolts. Use a small amount of loctite and a 5/8" wrench. (pic 26)

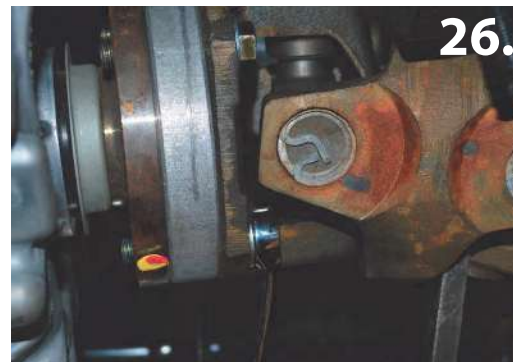

26. Install the McGaughy's crossmember with the large cut out on the driver side, using the factory hardware and a metric 24 wrench. (pic 27)

27. Reinstall the Christmas tree clamps using the holes provided in the crossmember.

28. Remove the clip that holds the electrical harness to the frame. (pic 28)

29. Make sure the wiring harness does not interfere with the drive line. (pic 29)

30. Now tighten the rubber transmission mount to the transmission crossmember using a metric 15 socket.